

V1.9

INSTALLATION
GUIDE



CAR MEDIA SYSTEMS



VNC1045-DBJ_{v3}

VISION
NAVICEIVER

IMPORTANT NOTES

This guide is an aid for the professional installation of the device.

Please note the following notes before installation:

- Always handle all parts of the device and the components of your vehicle with care.
- Under all circumstances observe the regulations of the vehicle manufacturer and do not make any changes to the vehicle which could impair driving safety.
- For safety reasons, disconnect the vehicle battery's ground connection before installation.
- Please always pay attention to the correct polarity of the connections.
- Please do not modify any harnesses or connections of the device or the vehicle as this may affect the warranty.
- Make sure that no cables are squashed or cause a short circuit.
- Do not lay cables in front of the airbags, e.g. in the dashboard or in a way that affects their function.

RECOMMENDED TOOLS:



Unlock devices



Plastic mounting wedges



Plastic drill



Cable ties



Phillips screwdriver or bit



Torx screwdriver or bit

RECOMMENDED ACCESSORIES:

Steering wheel control adapters:

VNA-LFB-FD2

FIAT DUCATO IV, PEUGEOT BOXER III, CITROËN JUMPER III (Type 290, since 2015) with radio preparation, ISO connection

VNA-LFB-FD3

FIAT DUCATO IV, PEUGEOT BOXER III, CITROËN JUMPER III (Type 290, since 2015) with original radio or original navigation system, CAN bus (52-PIN), USB port (optional), AUX port (optional)

VNA-LFB-FD4

FIAT DUCATO IV, PEUGEOT BOXER III, CITROËN JUMPER III (Type 290, since 2015) with original radio Delphi F250, ISO connector

VNA-LFB-FD5 (included)

FIAT DUCATO III, PEUGEOT BOXER II, CITROËN JUMPER II (Type 250, 2006 - 2015) ISO connection

INSTALLATION GUIDE



Only with radio ex-factory:
Pull the radio out of the slot using the release tools.

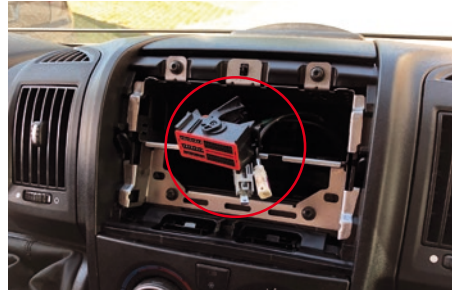

Only with radio ex-factory:
Remove the connectors on the back of the radio.



Only with radio ex-factory:
Loosen the 4 screws.

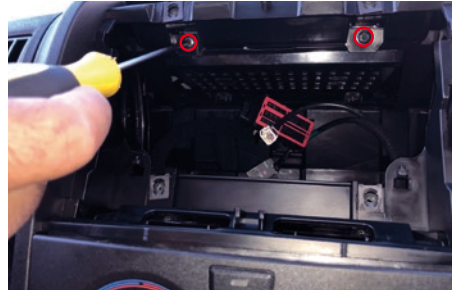

Loosen the 2 screws underneath.

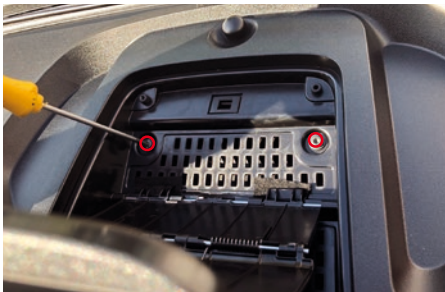

Open the storage tray and loosen the 2 screws.



Pull the storage tray upwards.

INSTALLATION GUIDE



Loosen the 2 screws underneath.



Remove the ventilation ducts on the left and right with a screwdriver and leverage as shown.



The dashboard should now look like this. Loosen the 2 screws.



Lift the rubber tray and remove the screw underneath.

INSTALLATION GUIDE



Remove the original panel.



Release the plugs.



Loosen the 2 screws.



Remove the original panel by lifting it and pulling it forward.



PRELIMINARY

INSTALLATION GUIDE



Loosen the 2 screws.



Pull the cover out from back to top (as shown).



Loosen the 2 screws and put the speedometer display on top (The plugs can stay).



Loosen the screws on the left side below the steering wheel.



Loosen the screw on the right side below the steering wheel.

INSTALLATION GUIDE



Then install the supplied enclosed panel, where the GPS antenna is integrated.

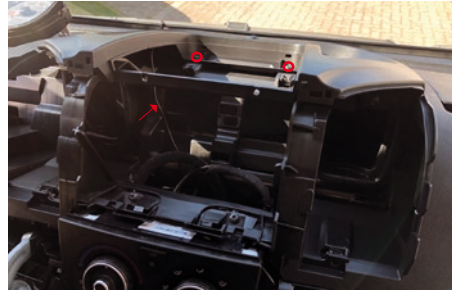

Pay attention to the GPS cable and fasten the 2 screws.
Then insert the cable of the GPS antenna to the device and connect it to the GPS socket as described on page 14.



Put in the storage tray and lift it, then attach the 2 screws.



Attach the 2 screws on the front.

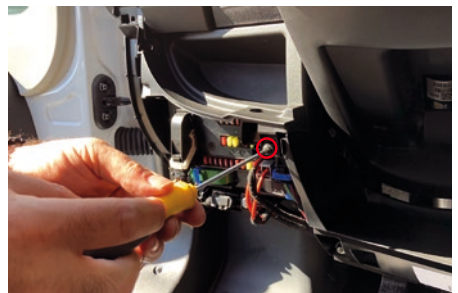

VNA-BTBOX connection* (optional):
Remove the cover from the fuse box. Loosen the screw.

INSTALLATION GUIDE

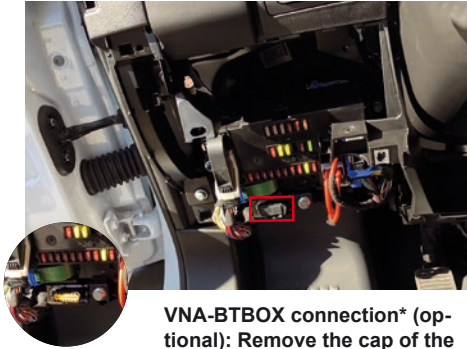

VNA-BTBOX connection* (optional): Remove the cap of the connector.

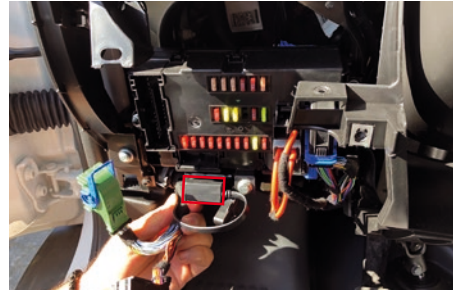

VNA-BTBOX connection* (optional): Connect the supplied VNA-BTBOX connector.



VNA-BTBOX connection* (optional): Lay the VNA-BTBOX connection cable.

(like shown)

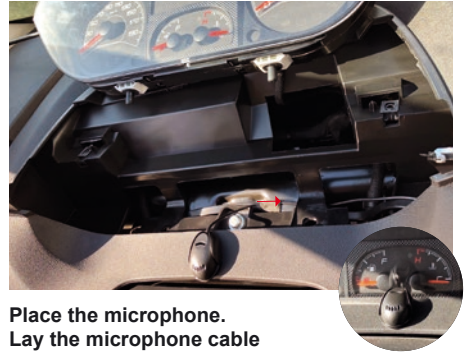

Place the microphone.
Lay the microphone cable as shown.

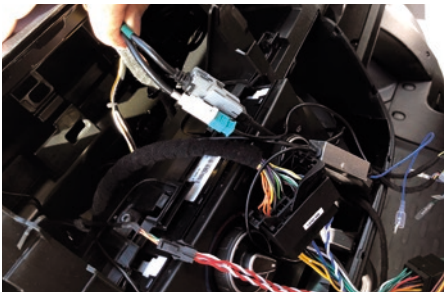

(Picture shows cable with factory installed radio)

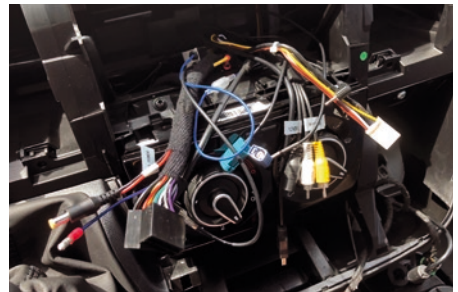

(Picture shows cable without factory installed radio)

Connect the respective cables to the ESX device as described from page 14 on.

* Optional accessories

INSTALLATION GUIDE



Put in the speedometer display and the cover.



Slide the ESX device into the slot.



Attach the screws.



ESX device after the installation.



Attach the screw and set in the rubber tray.



STEERING WHEEL CONTROL (optional adapter required)

Steering wheel control - teaching multifunction buttons

Switch to the system settings of the device and select „Steering wheel control“.

Then the following menu appears:

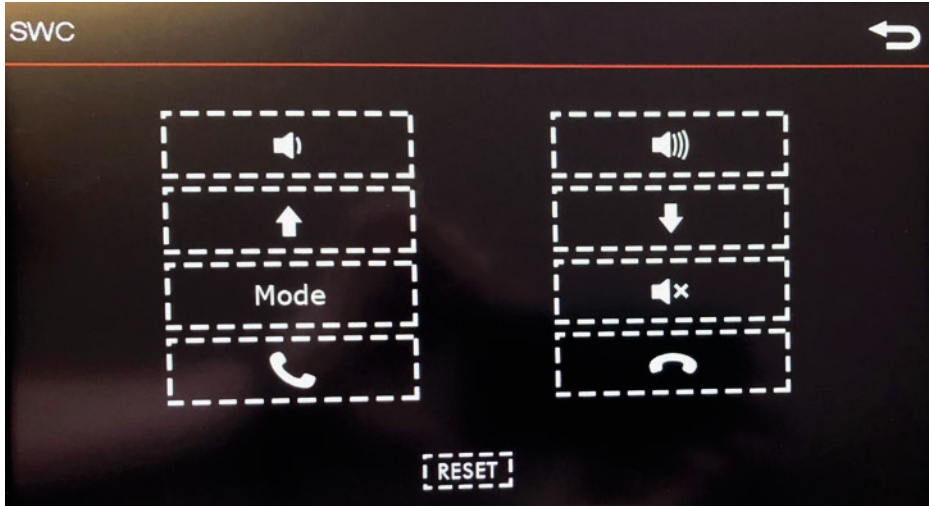







Press at first on “RESET”. Then press on the desired function and then on the regarding button on the multifunction steering wheel via which this function is to be controlled. After you have successfully assigned a function, the field is highlighted.

SCOPE OF DELIVERY

ITEM	IMAGE	AMOUNT
Main Device		1
Panel incl. GPS Antenna		1
MicroSD Memory Card 8 GB Navigation Software		1
Remote Controller		1
Microphone		1
Antenna Splitter (active) for FM/DAB + Radio Reception		1

SCOPE OF DELIVERY

ITEM	IMAGE	AMOUNT
Audio Cables		1
Camera/AUX/Video Cables incl. Video Box (Camera relay)		1
Video Cables		1
USB Extension		1
System Cable		1
Steering Wheel Control Adapter		1

CONNECTION DIAGRAM

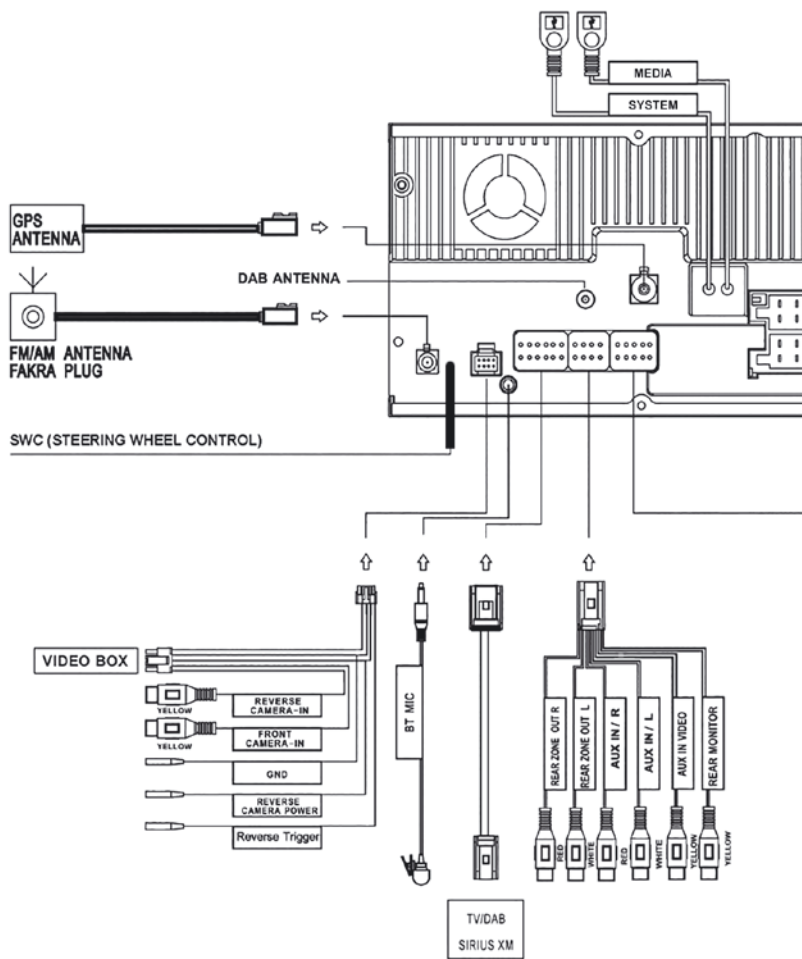

CONNECTION DIAGRAM

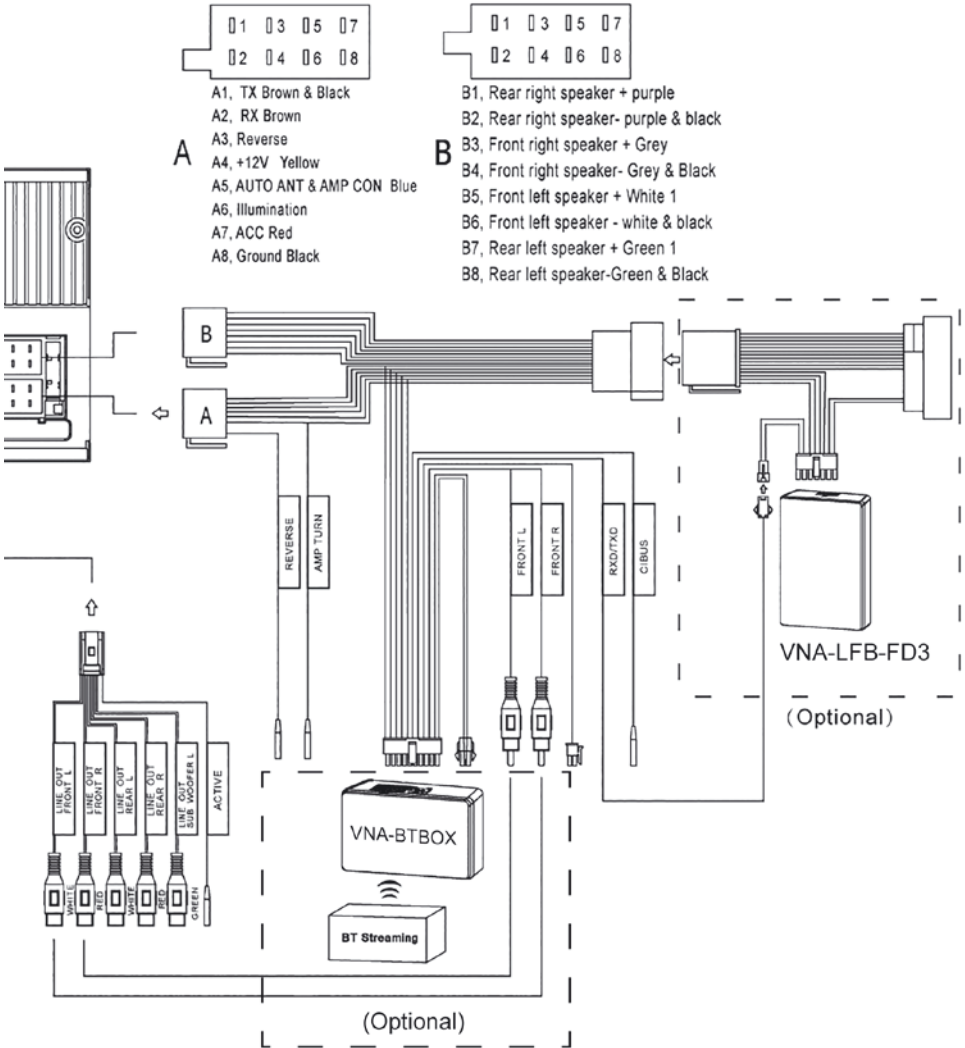

CONNECTION ANTENNA SPLITTER

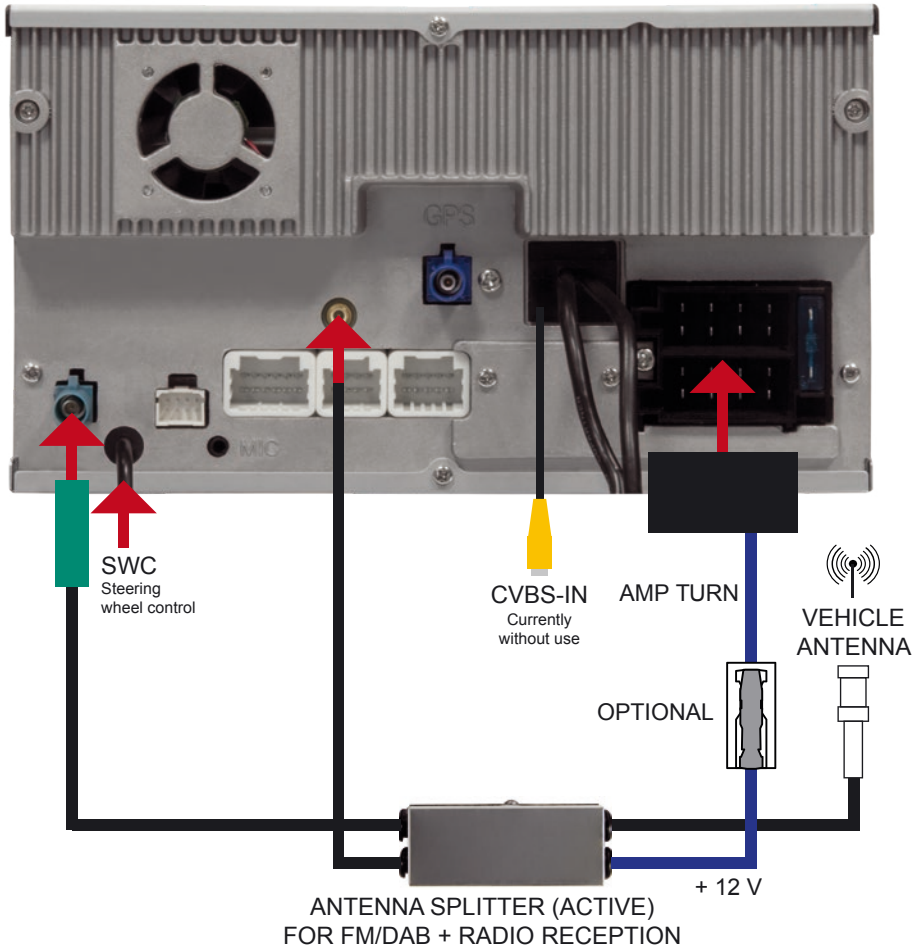

CONNECTION CAMERAS

Rear View Camera

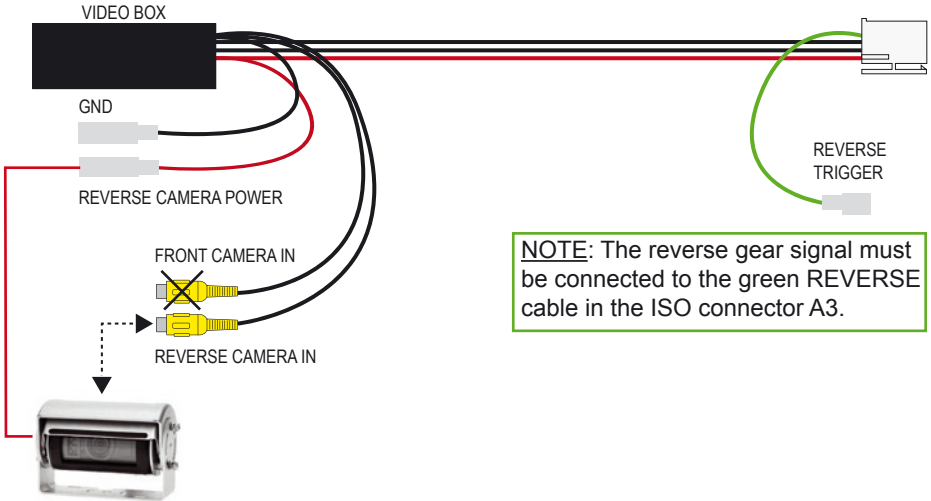

Example: VNA-RCAM-SHUTTER

Dual Lens Camera 1

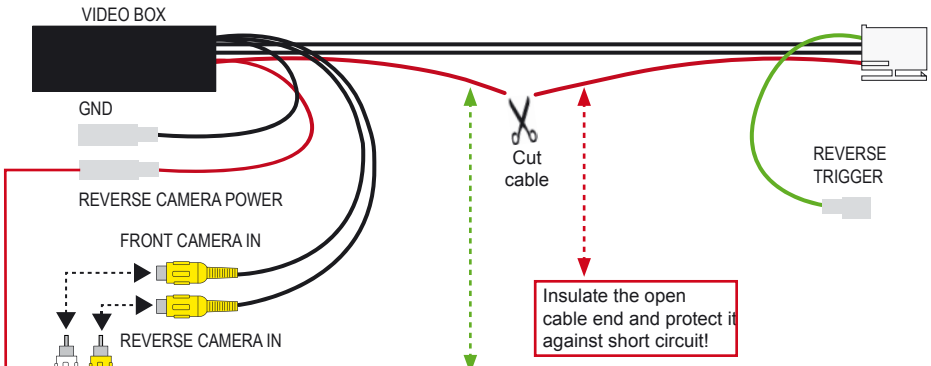

Connect together with the signal cable from the reverse gear of the green REVERSE cable in the ISO connector A3.

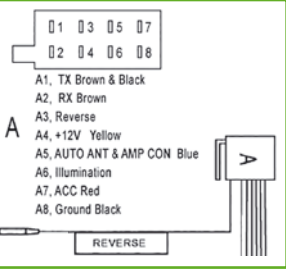

Example: VNA-RCAM-DUALSHUTTER

Connect the camera power supply to the ignition plus in the ISO connector A7.

CONNECTION CAMERAS

Dual Lens Camera 2

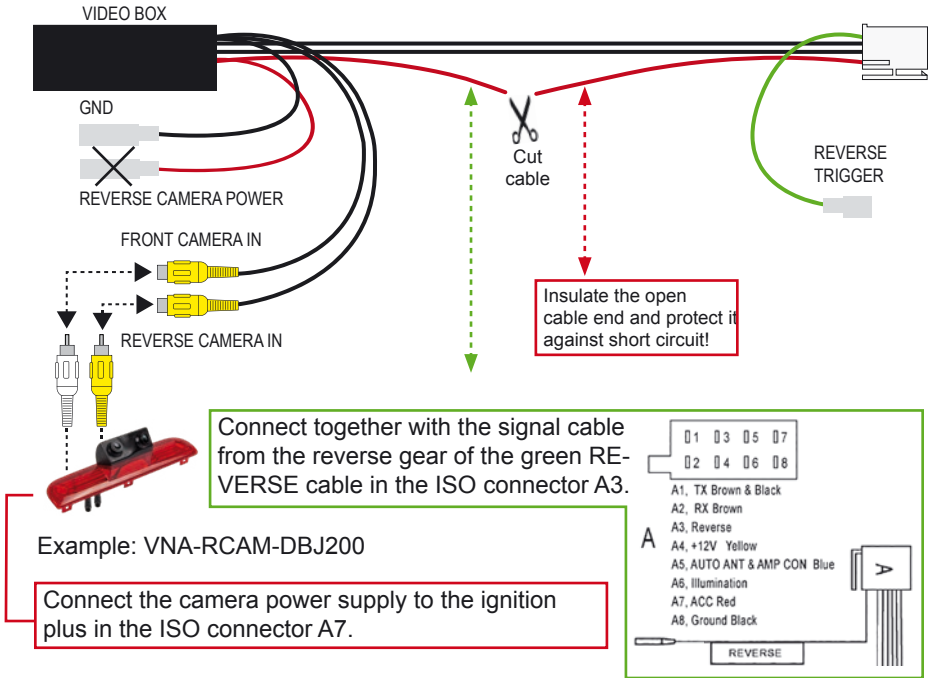

CONNECTION CAMERAS

Dual Lens Camera 3

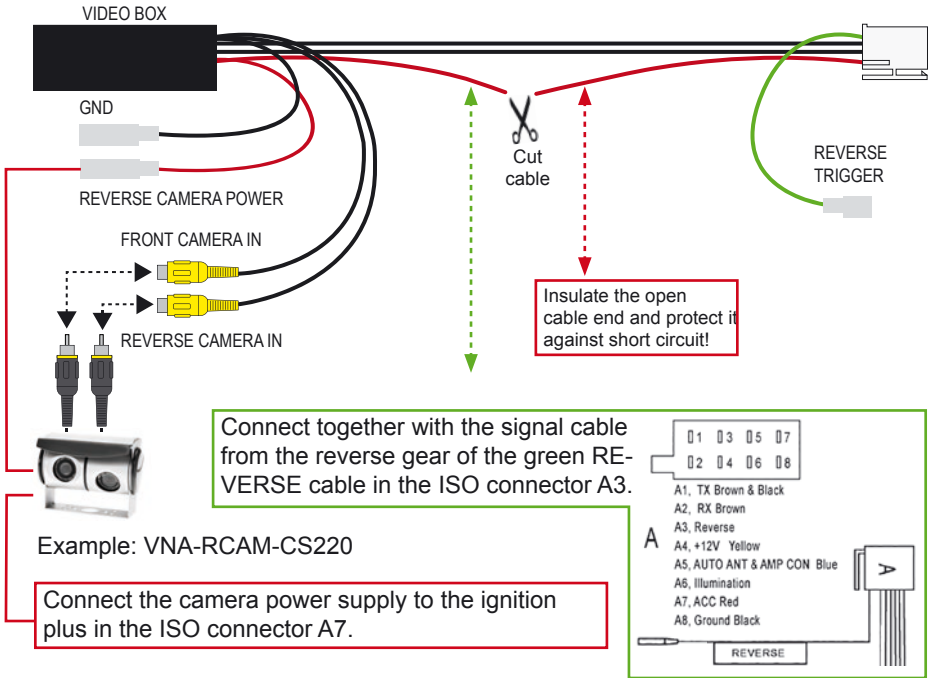



CAR MEDIA SYSTEMS



ESX Car Media Systems · Audio Design GmbH
Am Breilingsweg 3 · D-76709 Kronau/Germany
Tel. +49 7253 - 9465-0 · Fax +49 7253 - 946510
www.esxnavi.de - www.audiodesign.de

©2019 All Rights Reserved / Alle Rechte vorbehalten
Reprinting and reproduction, even in part, is prohibited.