

V1.1

INSTALLATION GUIDE

INCL. START-UP INSTRUCTIONS,
CAMERA SETTINGS,
GPS RECEPTION, 4G/LTE
and much more.



CAR MEDIA SYSTEMS

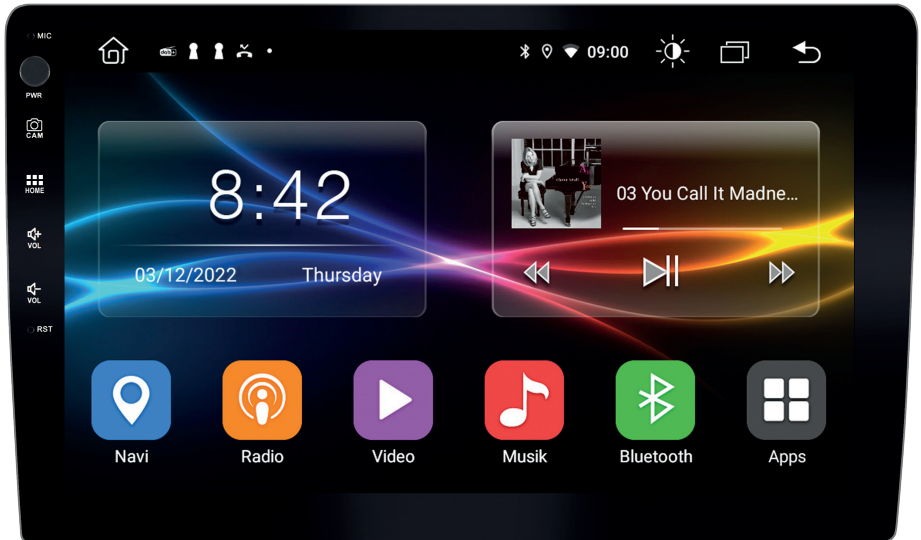

VN1040-4G V4R

SMART NAVICEIVER
MOBILE INTERNET READY
VISION ANDROID™ SERIES

IMPORTANT NOTES

This guide is an aid for the professional installation of the device.

Please note the following notes before installation:

- Always handle all parts of the device and the components of your vehicle with care.
- Under all circumstances observe the regulations of the vehicle manufacturer and do not make any changes to the vehicle which could impair driving safety.
- For safety reasons, disconnect the vehicle battery's ground connection before installation.
- Please always pay attention to the correct polarity of the connections.
- Please do not modify any harnesses or connections of the device or the vehicle as this may affect the warranty.
- Make sure that no cables are squashed or cause a short circuit.
- Do not lay cables in front of the airbags, e.g. in the dashboard or in a way that affects their function.

⚠ NOTE:

For many vehicle models, a vehicle-specific 1-DIN installation set is required for professional installation. In order to be able to use the existing steering wheel remote control of your vehicle, a vehicle-specific adapter may also be required. You can obtain information about this on the Internet or from your specialist dealer.

SD CARD SLOT

If you are using navigation software that is on a micro SD card, you must insert it into the MicroSD card slot. This is on the back of the display on the left, slightly above the middle. Therefore, insert the MicroSD card into the card slot before installing the device.

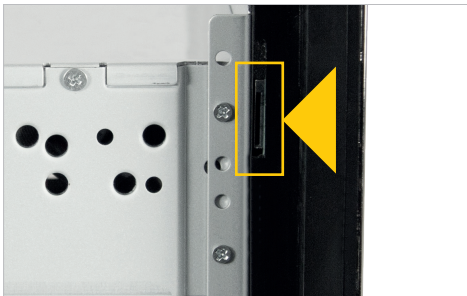

INSTALLATION HINTS

Please note the following steps when installing the device:

- 1 Original radio / navigation system**
If available, first remove the original radio / navigation device. Use suitable unlocking tools to pull the device out of the dashboard. Then pull the cable plug from the device and leave it accessible in the radio slot.
- 2 Cabling of the ESX main device**
Lay the supplied cable sets and antennas in the vehicle. Please note the information on the next page. Then connect all cable sets, antennas and dongles to the ESX main device as described on page 6. Then plug in the cable plug from the radio slot of the vehicle on the ESX main unit or on its vehicle-specific system cable set.
- 3 Installation of the ESX main device**
Now the ESX main device can be inserted into the 1-DIN installation slot of the vehicle.
- 4 Functional test**
Before you complete the installation, you should perform a function test. Check all functions of the ESX naviceiver including the steering wheel remote control of the vehicle.

RECOMMENDED TOOLS



T25

Torx T25 screwdriver or bit



Phillips screwdriver

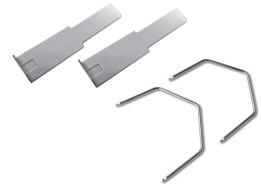

Unlocking tools









Cable ties



Plastic mounting wedges

SCOPE OF DELIVERY

ITEM	FIGURE	QUANTITY
<p>Main device Art.-Nr. VN1040-4G V4R</p>		<p>1</p>
<p>System cable set with ISO connector (20-pin plug) Art. No. ZEOS-A80650-022</p>	<p>S</p> 	<p>1</p>
<p>AV cable set 1 with audio and video connections incl. rear view camera (14-pin plug) Art. No. ZERW-120014-207</p>	<p>A</p> 	<p>1</p>
<p>USB port 1 (4-pin plug) Art. No. ZECL-290004-217</p>	<p>B</p> 	<p>1</p>
<p>4G/LTE dongle (6-pin plug) Art. No. ZESW-012900-004</p>	<p>C</p> 	<p>1</p>
<p>USB port 2 (8-pin plug) Art. No. ZECL-294008-201</p>	<p>D</p> 	<p>1</p>
<p>Camera cable set for HD rear view camera (10-pin connector) Art.-Nr. ZECM-AHDCAM-002</p>	<p>E</p> 	<p>1</p>
<p>AV cable set 2 with power, audio and video connections, additional camera input (8-pin connector) Art. Nr: ZERW-120008-210</p>	<p>G</p> 	<p>1</p>

SCOPE OF DELIVERY

ITEM	FIGURE	QUANTITY
<p>Installation friendly AV cable set 2, only connections for the additional camera (8-pin connector) Art. Nr: ZERW-120008-212</p>		1
<p>Y-adapter for the external microphone and the receiver of the separately available remote control (6-pin plug) Art. No. ZERW-121506-200</p>		1
<p>External microphone (Mini jack) Art. No. ZECL-035201-330</p>		1
<p>GPS antenna Art. No. ZESW-011701-007</p>		1
<p>DAB antenna Art. No. VNA-ANT-DAB5</p>		1
<p>4G/LTE antenna Art. No. VNA-LTE</p>		1
<p>VNA-LFB-FD6 Adapter for analog steering wheel remote control Only at VNC1040-DBJ-4G, VNC1045-DBJ-4G, VNC1040-F8-4G, VNC1045-F8-4G</p>		1

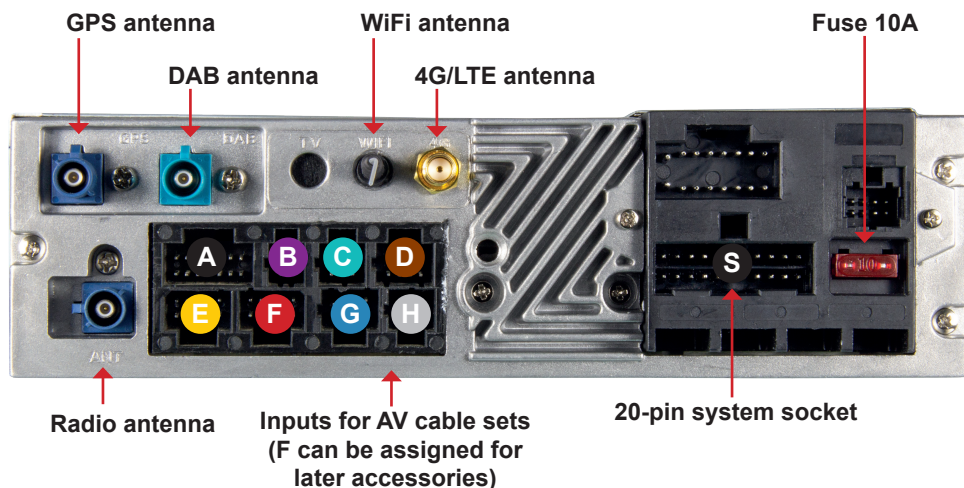

S System cable set 1 (20-pin connector, black)

Cable brown (BRAKE):	Connection for handbrake signal (ground)
Cable pink (REVERSE):	Connection for reverse gear signal (+ 12V)
Cable white (KEY1):	Connection for analog steering wheel control (left)
Cable black/white (KEY2):	Connection for analog steering wheel control (right)
Cable brown/black (CAN-RXD):	Currently not used
Cable black (GND):	Ground connection for devices such as cameras
Cable orange (AMP CONT)*:	Remote turn-on signal for external amplifiers (+12V)

* must be activated in the Naviceiver in the app "DSP" under "EXT AMP"

NOTE:

The handbrake signal must be connected to BRAKE. When the handbrake is applied, the signal must be connected to ground. According to legal regulations, the device may only play videos on the main screen when the handbrake is engaged. The connection cable must therefore not be permanently connected to ground. While driving, the screen is switched off to avoid accidents caused by carelessness.

A AV cable set 1 (14-pin connector, black)

RCA white (FL):	Audio output Front/Left
RCA red (FR):	Audio output Front/Right
RCA white (RL):	Audio output Rear/Left
RCA red (RR):	Audio output Rear/Right
RCA green (SUB):	Audio output Subwoofer
RCA yellow (VIDEO OUT 1):	Video output for external monitor 1
RCA yellow (VIDEO OUT 2):	Video output for external monitor 2
RCA yellow (VIDEO AUX IN):	Video input for an external signal source
RCA yellow (R-CAM IN):	Video input for rear view cam

B USB port 1 (4-pin plug, purple)

Use this USB port for USB storage media. For example, the cable can be routed into the glove compartment so that the USB socket is accessible there.

C 4G/LTE dongle (6-pin plug, turquoise)

Please note the information on page 10.

D USB port 2 (8-pin plug, brown)

Use this USB port in conjunction with the Media Connect function to connect your Android smartphone to the Naviceiver.

E Camera cable set for HD rear view cam (10-pin connector, yellow)

RCA yellow (R-CAM HD IN):

Video input for analog HD rear view camera*

RCA black (F-CAM HD IN):

Video input for analog HD front/additional camera*

* Only compatible HD cameras

F Not in use

G AV cable set 2 (8-pin plug, blue)

RCA red (AUX IN R):

Aux audio output Rear/Right

RCA white (AUX IN L):

Aux audio output Rear/Left

RCA yellow (F-CAM IN):

Video input for the front or additional cameras

Cable brown BRAKE:

Hand brake connection (Ground)

Cable yellow (CAM +12V):

Power supply for cameras

Cable black (CAM GND):

Ground connection for cameras

G Installation friendly AV cable set 2 (8-pin plug, blue)

RCA yellow (F-CAM IN):

Video input for the front or additional cameras

Cable yellow (CAM +12V):

Power supply for cameras

Cable black (CAM GND):

Ground connection for cameras

H Y-adapter (6-pin plug, grey)

Red jack:

Connection for the IR receiver of the optionally available remote controller **VNA-REM40**

Black jack:

Connection for the included external microphone

NOTE: You can find more information about camera settings from page 12 onwards.

GENERAL INSTALLATION INSTRUCTIONS

GPS antenna

The GPS antenna should be glued horizontally to the dashboard with the adhesive side down. Reception is not possible with a metal-coated pane. Choose a level spot with a clear view of the sky. The location should be about 50 - 70 cm away from the main unit, otherwise the GPS measurement accuracy will decrease. When installing the GPS antenna in the vehicle, the GPS accuracy is determined by the installation position and the body shape of the vehicle. Accuracy is usually lower when the GPS antenna is installed in the dashboard.

Remove the foil on the bottom of the GPS antenna



NOTE: When using the device for the first time and installing the navigation software for the first time, the search for GPS signals can take up to 30 minutes. After enough GPS satellites have been found to determine the position, they are permanently stored in the device and can therefore be found more quickly. If no GPS satellites are found afterwards or the GPS reception is poor, please note the following:

In order for the navigation software to function properly, sufficient GPS reception must be ensured on the Naviceiver. This is significantly influenced by the installation position of the GPS antenna in the vehicle. Therefore, make sure that the GPS antenna is properly installed in your vehicle to ensure the best possible reception.

Depending on the location or the topographical conditions in the reception area, GPS reception can vary and thus affect the functionality of the navigation software. GPS reception is also dependent on local satellite reception, which could be affected by current or global events.

Under certain circumstances, GPS reception can also be impaired by electronic devices such as smartphones, inductive charging cradle or toll devices (e.g. Telepass, GO-Box etc.) in the vicinity of the GPS antenna. In this case, reposition the electronic devices.

External microphone

The external microphone should be positioned in an easily accessible place, e.g. next to the sun visor or on the steering column.

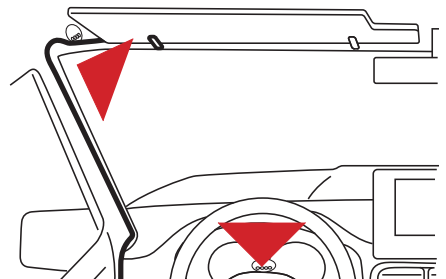

GENERAL INSTALLATION INSTRUCTIONS

DAB antenna

In newer vehicles, the original vehicle antenna can usually be used for both analogue and digital radio reception. The included DAB window antenna should only be used if you cannot use a fender or roof antenna. If necessary, active antennas and active antenna splitters from specialist shops improve radio reception significantly.

Route the DAB antenna to the windshield on the passenger side A-pillar. You can lay the connecting cable under the A-pillar and then route it through the dashboard to the radio slot.

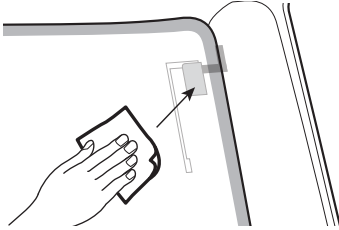

Clean the windscreen with a suitable cleaning cloth before sticking the antenna onto the screen.

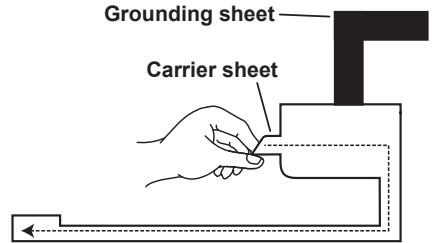

Remove the backing sheet of the black amplifier unit and the film antenna and stick the antenna onto the glass. Glue the copper-colored metal face of the grounding blade to a bare metal part of the vehicle.

USB ports

Route the USB ports to the desired location, such as the glove box or install the USB socket in the dashboard.

SETUP THE 4G/LTE INTERNET CONNECTION

1. First lay the two 4G/LTE antennas inside the dashboard towards the windshield, one antenna for the left and one for the right.
2. Ideally, you should stick the antennas to the windshield to ensure optimal reception.
3. Then insert your SIM card in the 4G/LTE dongle:



Open the dongle by pushing the flap to the right.

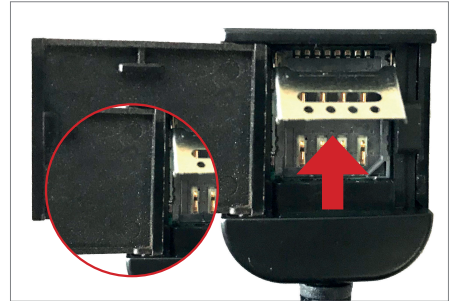

Now open the metal flap carefully with a suitable tool by pushing the flap up.

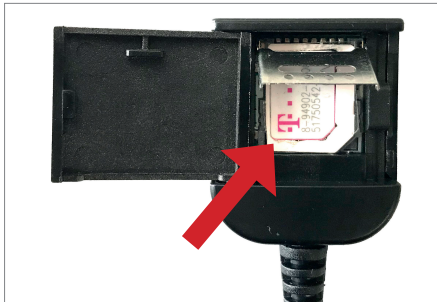

Then insert your SIM card with the contacts facing down.

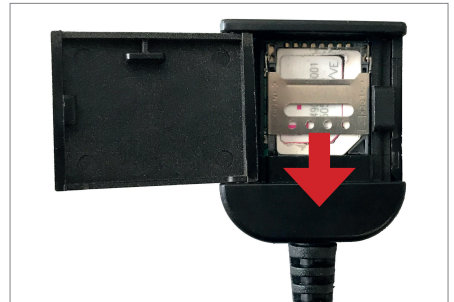

Close and lock the metal flap carefully by pushing the flap down.

Compatible SIM cards:



Micro SIM



Nano SIM with adapter
for Micro SIM

SETUP THE 4G/LTE INTERNET CONNECTION

4. Then turn on the device to test the 4G/LTE connection.

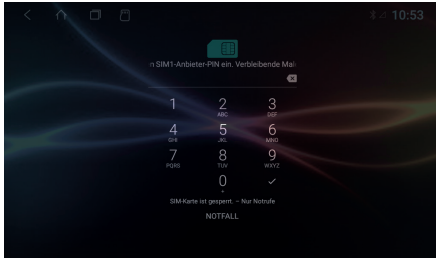

After the device has started, enter your **4-digit PIN code** of the SIM card here. Confirm the entry with the tick.

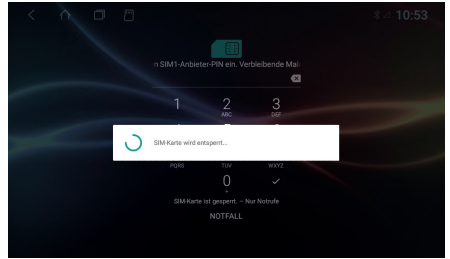

After successful entry, the SIM card is unlocked.

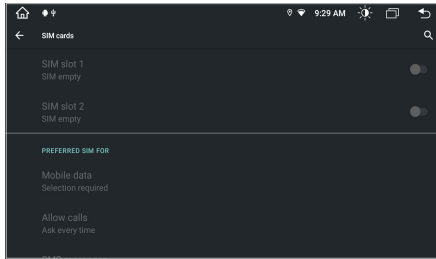

If the device is successfully connected to the mobile Internet, the **4G** symbol appears in the status bar at the top right. The connection can be switched off again under **SIM slot 1** in the **SIM cards** menu.

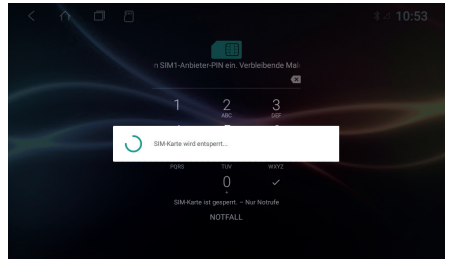

If the device is turned off, you have to enter the PIN code of the SIM card again after each restart, just like with a smartphone*.

5. After a successful test, install the 4G/LTE dongle in the radio slot or dashboard.

* The SIM card's PIN code can be deactivated in standard smartphones. To do this, insert the SIM card in a smartphone and deactivate it accordingly. The steps involved vary depending on the smartphone.

REAR VIEW CAMERA SETTINGS

If you have connected a compatible rear view camera to the camera input of the device, the camera image is automatically displayed when you engage reverse gear. This view is also shown when the camera direct button is pressed.

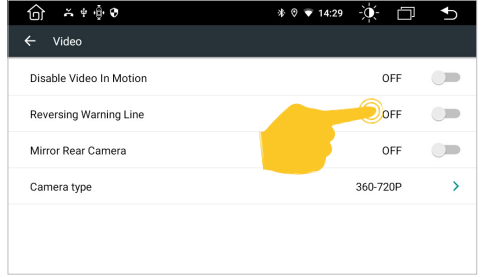

If your rear-view camera does not have dynamic warning lines, you can use the device's static parking lines.

In Settings, open the Auto Settings menu, then tap Video. Activate the warning lines or mirror the camera image there.

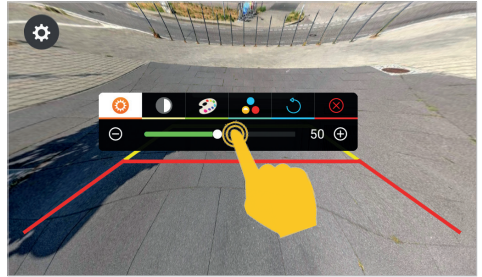

When you tap the display, a gear symbol appears in the top left. Tap it to open the camera view settings.

Here you can make various settings according to your requirements. Exit the settings with the red X.

Important note: If no camera is connected, this view shows "No Signal".

REAR VIEW CAMERA SETTINGS

If you have connected a compatible additional camera to the additional camera input of the device, this will be displayed via the F-CAM app. This view is also shown when pressing the camera direct button twice (refer to page 6), if the additional camera has been activated before.

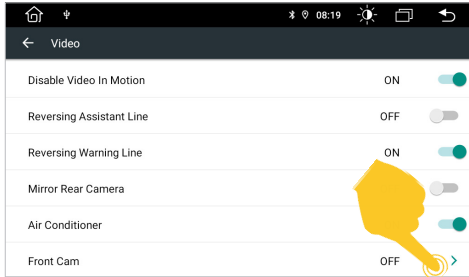

Under Settings, open the Car Settings menu, then tap on Video. Activate the corresponding input under Front Cam.

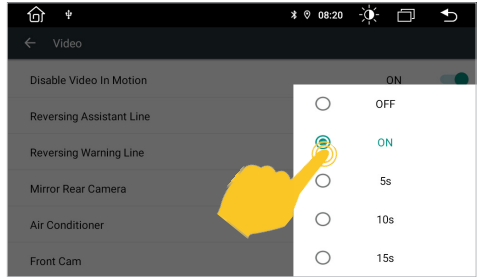

If a time selection is made here instead of ON, e.g. 5s, the application closes automatically after 5 seconds and the main screen is shown again.

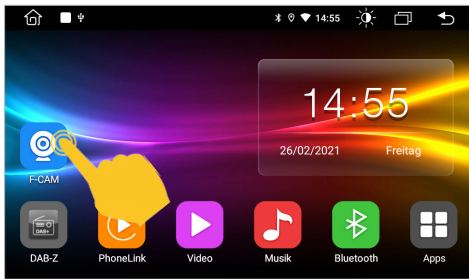

Tap on F-CAM in the app menu to open the additional camera view.



To exit the view, tap the white X in the top right corner.



Alternatively, you can also connect a double-lens reversing camera with far vision, which you can then use as a rear-view mirror camera via the F-CAM app.



As soon as you engage reverse gear, the close-up view of the rear-view camera is activated again.

HD CAMERA SETTING

If you use the cable set "E" for HD cameras (10-pin connector, yellow), you must change the settings in the ESX Naviceiver accordingly. To do this, proceed as follows:

Apps > Settings
> Car settings
> Video

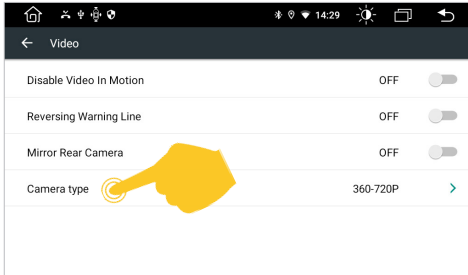

Tap on **Camera type**.

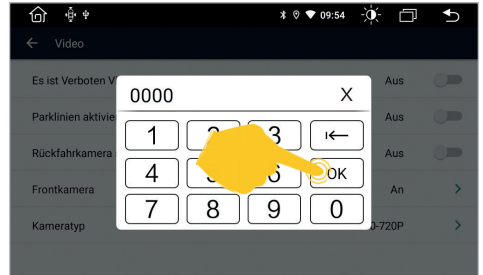

Enter the unlock code **0000**. Confirm with **OK**.

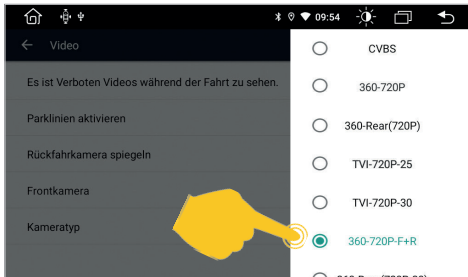

The setting for all ESX HD cameras is **360-720P F+R**.

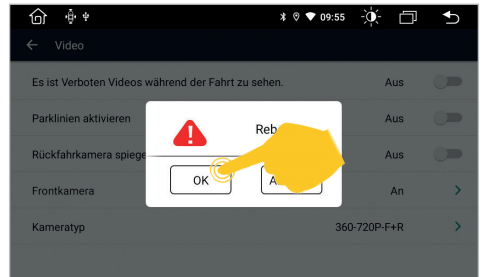

Agree to the "reboot" with **OK**. The ESX Naviceiver will then restart.

TECHNICAL DATA / RADIO SYSTEM TYPE

Function	Band Information	Frequency Range	Max. emitted power
Satellite System	GPS GLONASS	1.575 MHz 1.602 MHz	–
AM Radio	Medium wave	520 - 1.700 Hz	–
FM Radio	Band II	87,5 - 108 MHz	–
DAB Radio	Band III (5A – 13F)	174,9 - 239,2 MHz	–
4G / LTE	FDD (Band 1 / 3 / 5 / 7 / 8 / 20) TDD (Band 38 / 39 / 40 / 41)	800 - 2.100 MHz 1.900 - 2.600 MHz	22,3 dBm 21,9 dBm
3G	WCDMA (Band 1 / 5 / 8)	900 - 2.100 MHz	22,8 dBm
Bluetooth	Version 5.0	2.400 MHz - 2.484 MHz	30,0 dBm
WiFi / W-LAN	IEEE802.11b/g/n	2.400 MHz 5.000 MHz	16,0 dBm 13,0 dBm



CAR MEDIA SYSTEMS



ESX Car Media Systems · Audio Design GmbH
Am Breilingsweg 3 · D-76709 Kronau/Germany
Tel. +49 7253 - 9465-0 · Fax +49 7253 - 946510
www.esxnavi.de - www.audiodesign.de

© All rights reserved. Subject to technical changes and errors.